

Super Abrasive Honing Solutions

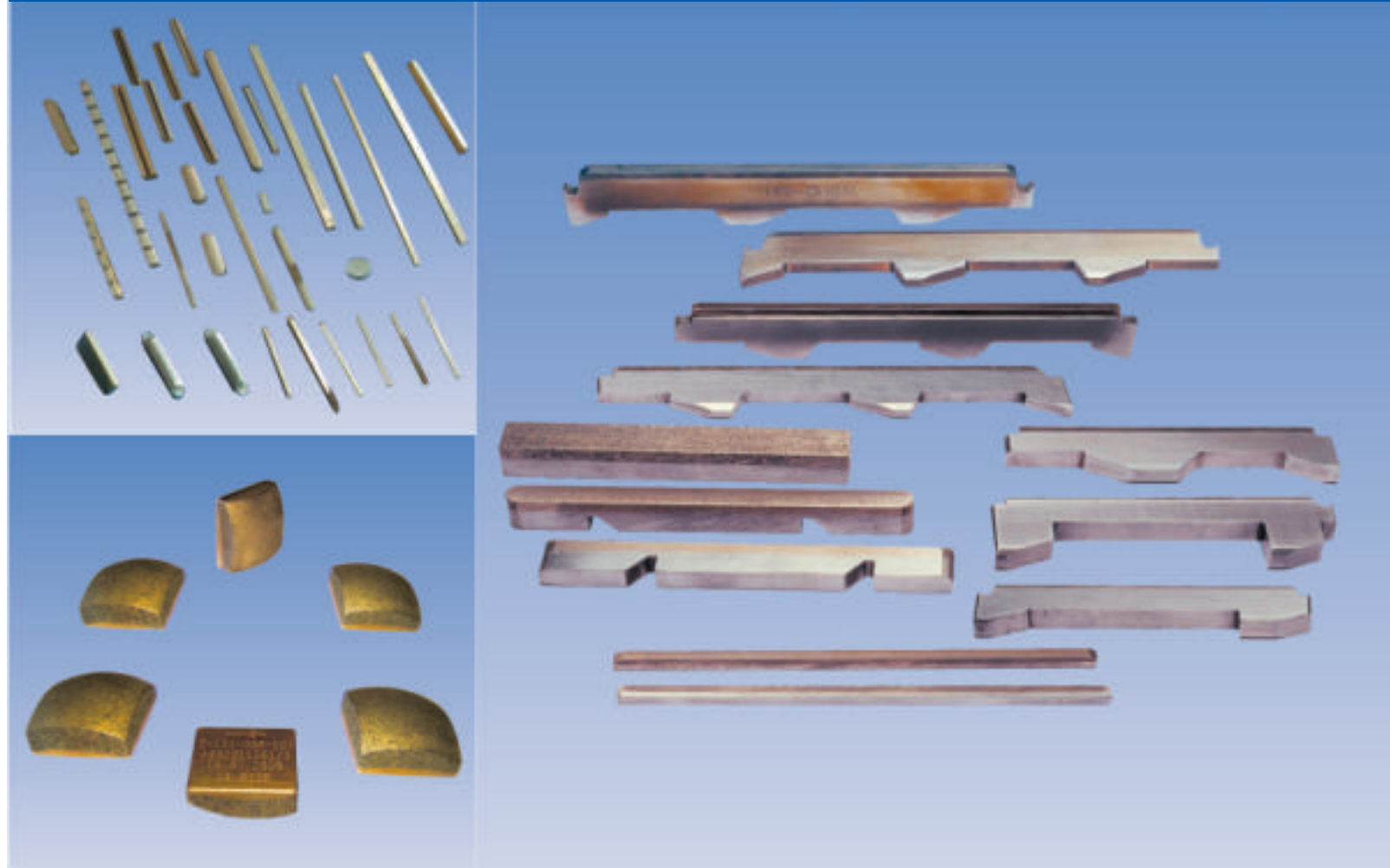

Honing Solutions

Earlier times in Honing, the abrasives used most commonly were Aluminium Oxide and Silicon Carbide. These conventional abrasives performed well but could remove only small amounts of stock and were not satisfactory on very hard materials.

Superabrasive Honing sticks, made from CBN or Diamond, have helped achieve material removal rates many times than what is possible with conventional honing stones. Almost any type of material can be successfully honed by one or both of these superabrasives. This includes all types of steel, alloys, super alloys, cast iron, carbides, platings and coatings, ceramics and glass.

Employing these super abrasives, Honing operations can replace fine boring and internal grinding operations and also certain lapping operations.

Range Offered

Wendt India, manufactures and supplies the broadest line of honing super abrasives Hones. The line includes a wide array of mounted and unmounted super abrasives Hones with many choices of grit types, sizes and specifications suited for every requirement. Wendt India Hones also produce close size control and accurate geometry at the same time.

Superabrasive grit and bond types offered

In metal bonds - Excellent for accelerated stock removal, close size control, accurate geometry and long abrasive life in **ferrous material**.

- **Diamond (D)**
In metal bonds - Excellent for accelerated stock removal, close size control, accurate geometry and long abrasive life in **cast iron, carbide, titanium, and other exotic materials**.
- **Wendt** can also offer Vitrified and Resin Bond Systems in CBN and Diamond for special applications.

Principal Movements in Honing

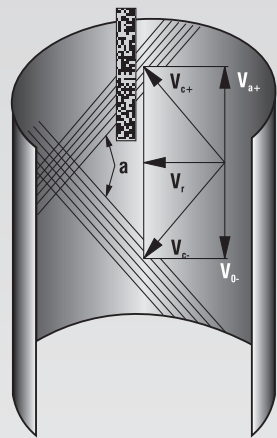

V_r = rotation speed
 V_o = oscillation speed
 V_c = resulting cutting speed
 $V_c = \sqrt{V_r^2 + V_o^2}$

In honing, the simultaneous rotary and reciprocating movements of the stick result in a cross hatch pattern on the workpiece surface (angle of incidence ranging from 30 to 70°).

Honing stick is the most decisive interface between machine and work piece. It determines the performance of the entire Honing process.

Surface Finish

Grit size generally determines the surface finish. Bigger the grit size, rougher the surface finish and greater the stock removal.

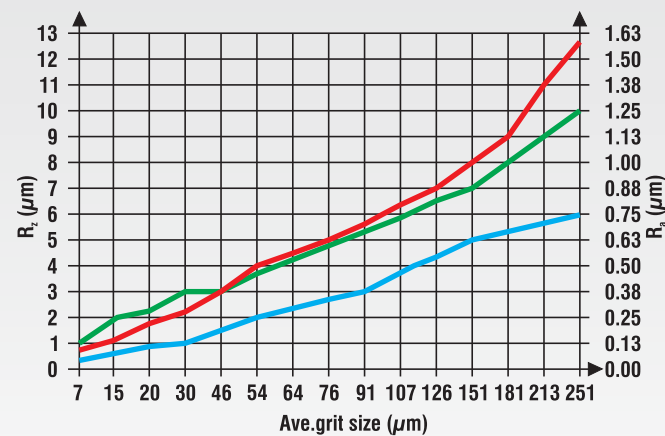

- Soft steel
- Gray cast iron 180-250 HRB
- Hardened steel 62 HRC

Super Abrasive Honing Solutions

Effect of Cutting Speeds on Stock Removal

Higher stock removal is possible with increased cutting speeds. Results show that stock removal rate is influenced more strongly by changes in oscillation speed (V_o) rather than rotational speed (V_r).

Higher oscillation speeds create larger hatch angles and these larger angles give improved stock removal rates.

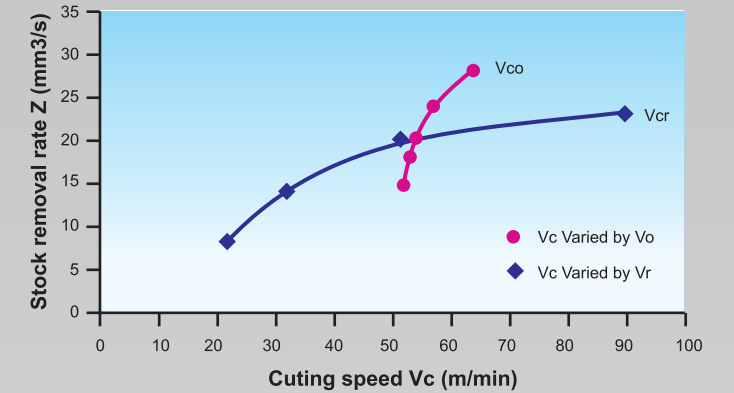

Terminology of Honing Sticks

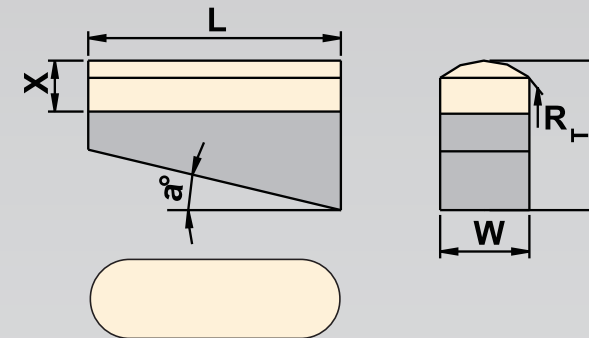

The variables mentioned in our honing stones are explained in the diagram ..

- L = Length of the honing stick
- T = Total thickness of the honing stone
- W = Width
- a = Degree
- X = Diamond impregnation
- R = Radius

Ordering Details

To determine the optimal honing stone, for the specific work in each case the more information provided, the greater the certainty. Table shows a few examples of these... By doing so you will facilitate the rapid, error-free processing of your orders...

1	2	3	4	5	6	7	8
A	25	5	1.5	1	40	B91	35 con
D	50	8	3	1.5	60	D30	100con
H	100	10	6	2.5	40	B126	50 con
I	125	15	10	3	60	D54'	75 con

- 1 = Shape of honing stick
- 2 = Length of Honing stone
- 3 = Thickness
- 4 = Width
- 5 = Diamond depth
- 6 = Radius
- 7 = Abrasive type / size
- 8 = concentration required

Tolerance for Dressing Metal Bond Honing Sticks

Parameters	Range (mm)	Tolerance (mm)	Parameters	Range (mm)	Tolerance (mm)
L (Length)	5 - 50	+0.2 - 0.5	H (Height)	1.0 - 10	+0.15 -0.05
	51 - 100	+0.3 -0.5		>10 - 15	+0.20 -0.05
	101 - 151	+0.5 -1.0		>15 - 25	+0.25 -0.05
W (Width)	1 - 3	- 0.05 -0.10	Parallelism on Width//	1 - 100	0.03
	>3 - 6	- 0.05 -0.15	Parallelism on Height//	>100 - 150	0.05
	>6 - 15	-0.05 -0.15	1 - 100	0.05	
	>15	-0.05 -0.20	>100 - 150	0.15	

▨ Abrasive Layer ▨ Metal Base

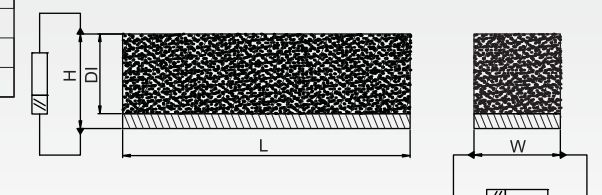

- **Integral Concept:** Here Honing stones and shoes are manufactured together, eliminating brazing process at the customer end. This provides enhancement in life and accuracy compared with the regular shoe mounting.



- **Ready to use:** We provide ready to use mandrels with trued Honing sticks. It eliminates truing process at customer's end there by achieving significant saving of machine and man power cost.

- **Progressive Honing Tool:** We provide sintered sleeve with wide range of abrasive grit sizes that provide maximum accuracy with high repeatability.

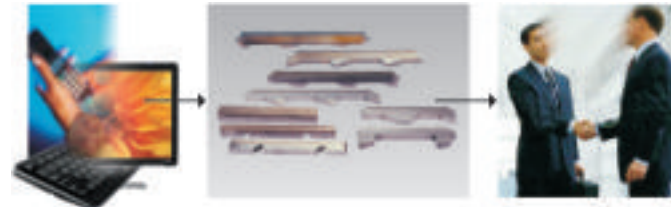

- **Stocking Strategy:** We can formulate a stocking strategy for Honing Sticks based on the mutual agreement through our SAP system. This means inventory reduction at customer end Customer gets exactly what he needs, when ever he needs it.

Typical Applications

Industry Segment	Components
Automobile	Gears, Cylinder Blocks, Connecting Rods etc.
Auto Ancillary	Gears, Rocker Arm, Connecting Rods, Fuel Injection Parts, Fork Shifter, Clutch Master Cylinder etc.
Engineering	Gun Barrel ,Hydraulic Tubing, Compressor parts etc..

WENDT (INDIA) LTD.

69/70, Sipcot Industrial Complex, Hosur-635 126, Tamil Nadu.
 Ph: +91-4344-276851, 276852, 276254, 405500, 405501.
 Fax: +91-4344-405620, E-mail: wil@wendtindia.com Web: www.wendtgroup.com

Regional Offices:

BANGALORE ● BARODA ● CHENNAI ● COIMBATORE ● DELHI ● FARIDABAD ● HYDERABAD ● HOSUR
 ● JAMSHEDPUR ● KOLKATA ● MUMBAI ● NAGPUR ● NASHIK ● PUNE ● RUDRAPUR

For more information contact:
 E-mail: sajuabraham@wendtindia.com
 venkateshms@wendtindia.com